



MANUAL

RADC 1.0

Radar Distance Control

Contents

Warning and safety instructions	3
Product description.....	4
System mounted on the truck.....	5
Signaling (function).....	5
Sensor installation.....	6
Sensor detection range.....	6
Recommended sensor location	7
Keep out / Interference zones.....	7
Hole pattern	8
Mounting tolerances	8
Object detection capability.....	9
Minimal reflection	9
Full reflection	9
Daily maintenance	10
Testing and maintenance	11
Specifications	12
Programming	13
Brake configuration (examples)	13
Product liabilities.....	15

Aspöck Systems GmbH
 Enzing 4 | 4722 Peuerbach | AUSTRIA
 Tel.: +43 72 76 / 26 70-0
 office@aspoeck.at | www.aspoeck.com

Warning and safety instructions in this manual



Draws attention to situations that can lead to death or serious injury if not avoided!



Denotes information that is important but not dangerous!

Please read these assembly instructions completely before starting assembly. These assembly instructions are intended for professional attachment manufacturers. Appropriate background knowledge is therefore assumed in these assembly instructions. It should be noted that some work may only be carried out by appropriately qualified personnel in order to avoid the risk of injury and to achieve the quality required for construction work.

If you have any questions or installation problems, call Aspöck customer service, the dealer or contact your authorised workshop.

- National mounting, installation and operating regulations must be observed.
- The product may only be used in accordance with the enclosed instructions and safety notes.
- Instructions can be found online at www.aspoeck.com/en/top/downloads.
- No modifications may be made to the product unless only the original spare parts intended for this purpose or spare parts approved by Aspöck are used and installed by professionally qualified personnel.
- Product liabilities are limited in item 9 of the GTCs. www.aspoeck.com/en/top/downloads

Product description

The **RADC 1.0** is a Ramp distance control with radar technology called RADC (Radar Distance Control).

The RADC 1.0 sensor is a ramp approach assistance and is only intended to be an addition to existing safety systems. The vehicle operator is always the first line of defense when it comes to safety when operating the equipment. This new system provides more safety when backing up by detecting objects it does not provide pedestrian protection.

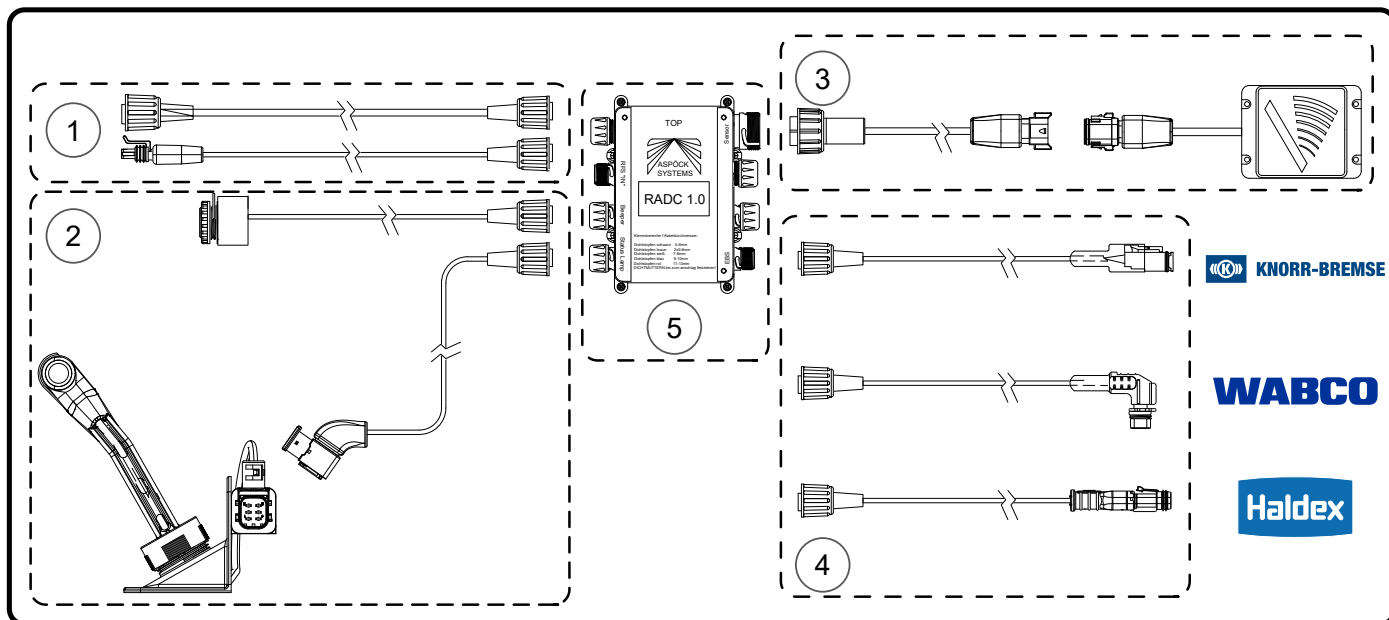

- ① Power supply: 2pin ASS2 or 2pin AMP Superseal
- ② Beeper and / or status lamp (warning system – recommended)
- ③ RADC 1.0 Sensor and sensor cable
- ④ EBS connecting cable
- ⑤ Junction Box

System mounted on the truck

The RADC 1.0 without warning systems for the vehicle owner is not recommended!

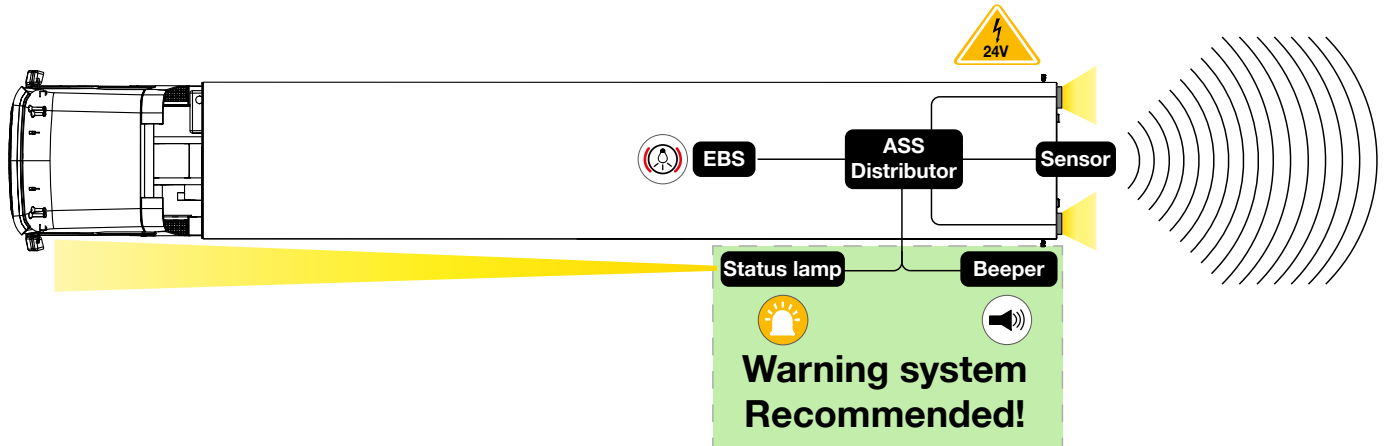

Signaling (function)

1. Mode: "OK", no object in detection zone

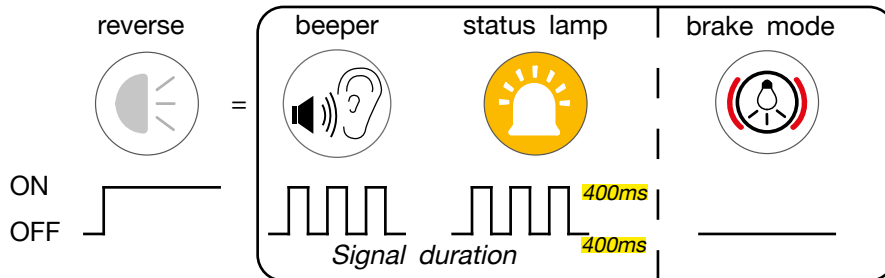

2. Mode: "OK", object in the detection zone

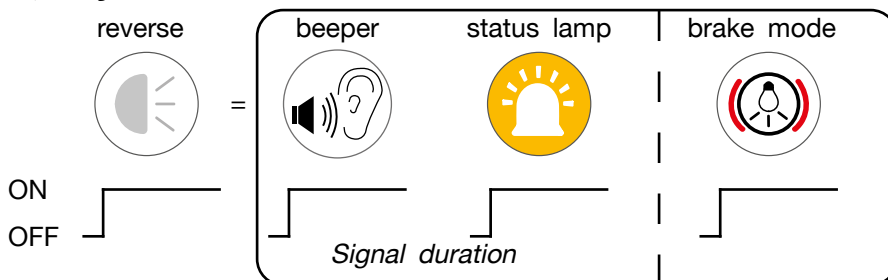

3. Mode: "NOK" system error

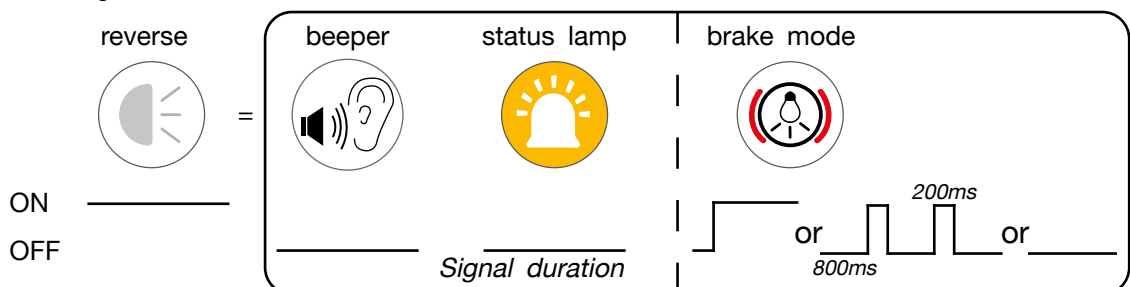

A component of the system has failed, is damaged and/or soiled.

Possible sources of error:

- The RADC 1.0 sensor is soiled and cannot send and receive any signal.
- A cable break, problems with the distributor or individual components of the system are damaged.
- Incorrect programming from the sensor to the EBS system.

Sensor installation

Take the time to familiarize yourself with all documents and the system components before installing the RADC 1.0 object detection system.

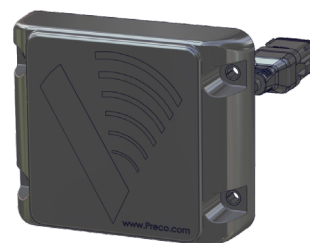

Sensor detection range

The sensor transmits and receives low power 24 GHz radar signals. This frequency band is legal throughout most of the world, but check your country's regulations before purchasing. It then processes the returned signals to determine if an object has reflected any energy back to the sensor.

The sensor is designed to process and report detections within 240 milliseconds (ms) allowing the operator to quickly respond to any object within the detection zone. Using the RADC 1.0 measures radial range, speed and angle, reflectivity, and other parameters of multiple stationary and moving targets simultaneously. This radar sensor has a wide horizontal field of view up to $\pm 75^\circ$ (150°).

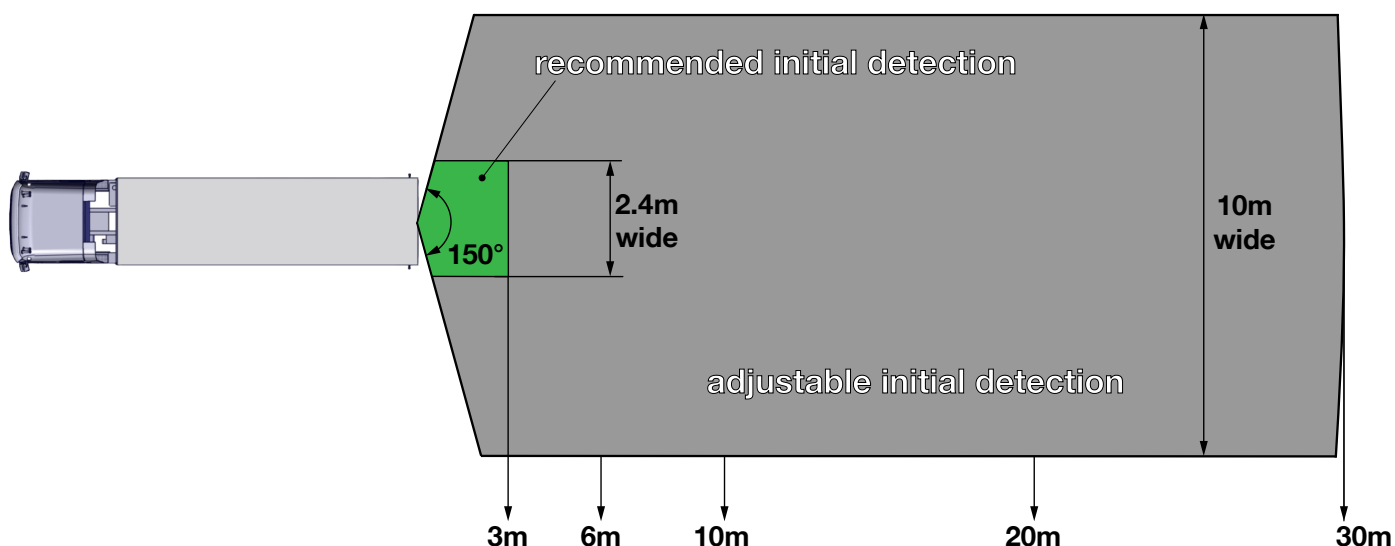

Recommended sensor location

The installation location of the sensor is critical for proper operation.

The sensor face should be positioned vertically to the ground and properly aligned. Mount the sensor in a location where it is well protected from debris and impact, but at the same time allows an unobstructed field of view that covers the targeted blind spot.

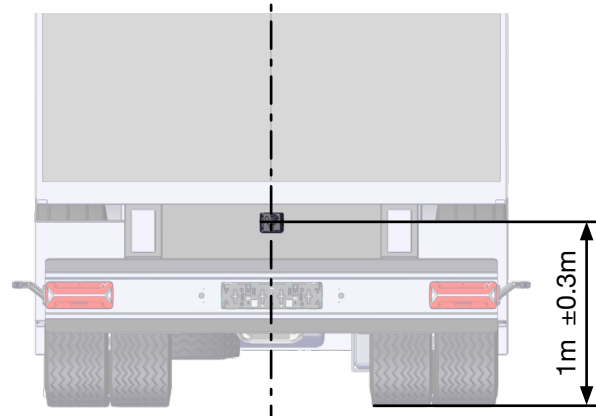

Keep out / Interference zones

For optimal performance, the sensor should protrude beyond any other portion of the vehicle. If this is not possible, it is important to understand how surrounding objects can impact the sensor's performance. The sensor's horizontal field of view is $\pm 75^\circ$ (150°) and the vertical field of view is $\pm 10^\circ$ (20°); however, metallic and other strong radar reflecting objects outside but near this field of view can cause interference. These objects must remain outside the expanded area shown as the "Keep Out Zones" below. If your specific implementation requires radar reflecting objects to reside in the Keep Out Zones, testing must be performed to determine their influence on the sensor's performance.

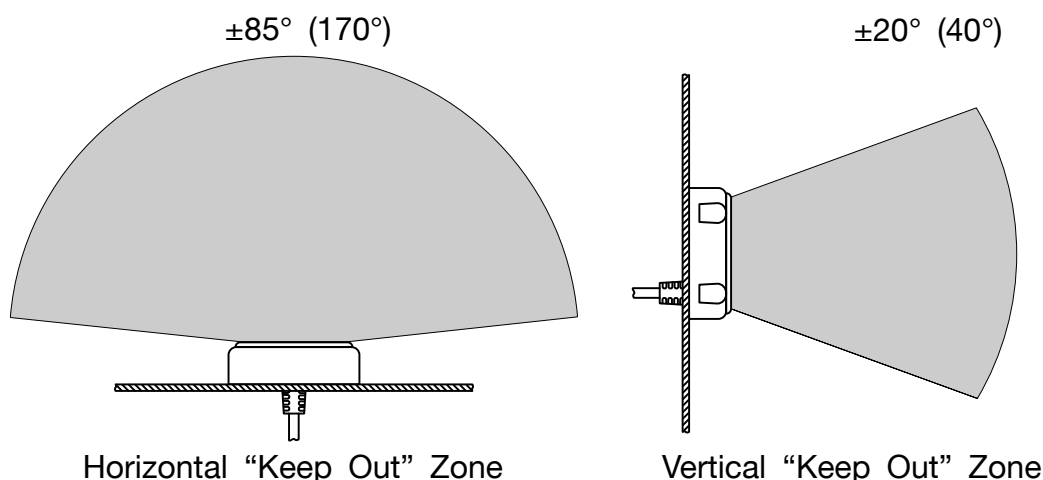

Before the RADC 1.0 is permanently installed on the equipment, verify the selected location provides a clear detection zone. Move the equipment to an open field with no objects in the sensor's field of view, temporarily attach the sensor to the equipment in the proposed location, apply power and activate the system. Verify that nothing is being detected.

Hole pattern

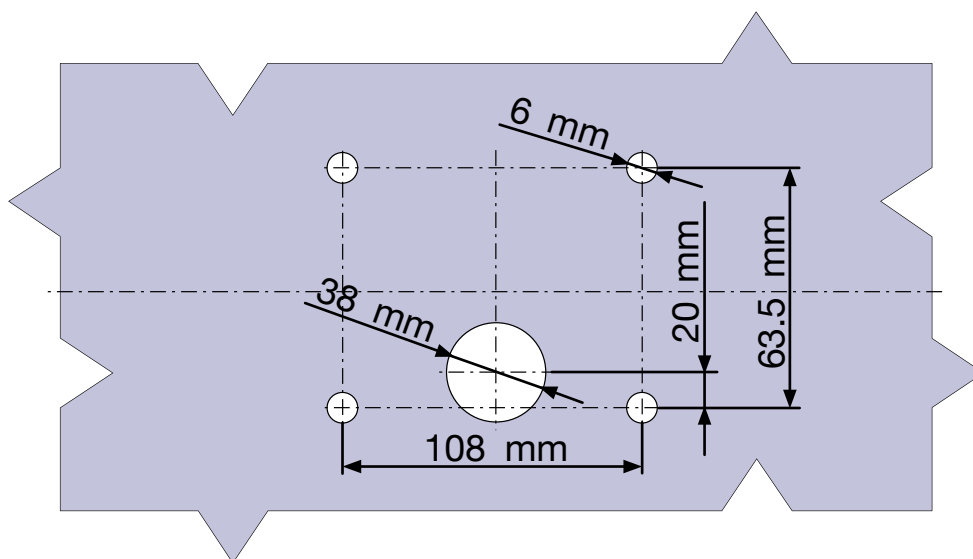
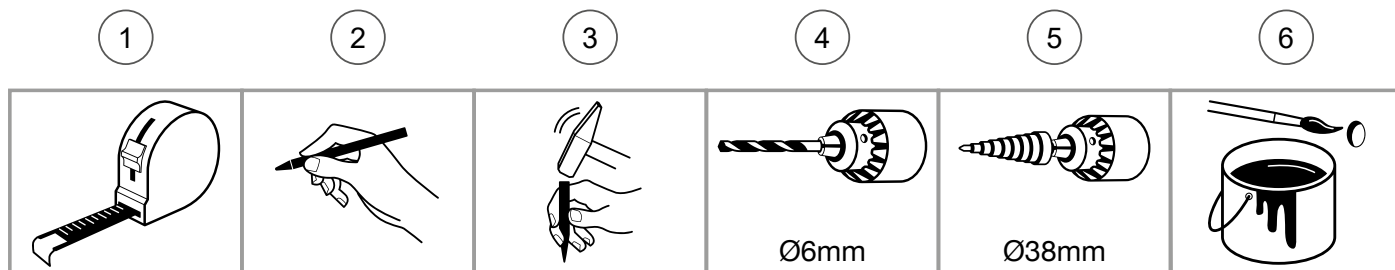

Mounting tolerances



Exceptions: When mounting at a height of more than 1.3m, the sensor can be angled downward a few degrees if necessary (less than 5° in most applications).

The performance of the sensor can be negatively affected if the sensor is tilted downward, resulting in false detection from the ground. Any time the sensor must be mounted outside of the mounting tolerances, performance should be tested. In some cases, especially with longer range models, it may be necessary to tilt the sensor upward to avoid false detections from the ground.

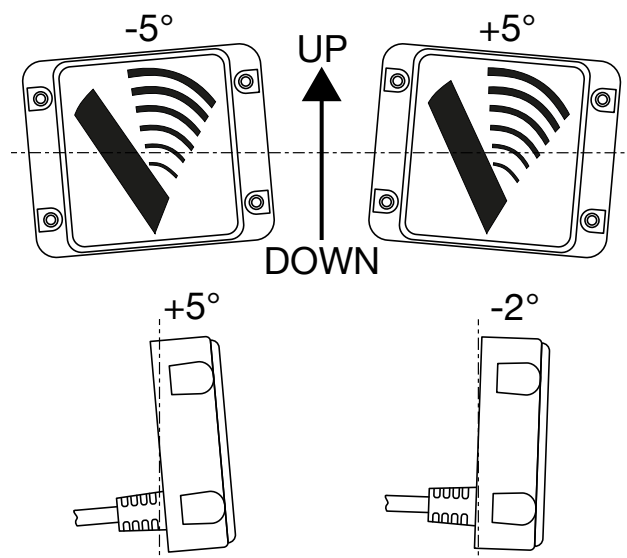

Object detection capability

The RADC 1.0 system is a ramp approach assistance and is only intended to be an addition to existing safety systems. The vehicle operator is always the first line of defense when it comes to safety when operating the equipment.



The amount of energy returned is based on a few factors:

- **Angle** – an object flat side perpendicular to the sensor will reflect more energy than an object at an angle. For an example of how angle can affect return energy.
- **Scattering** – a solid object reflects more energy than a non-solid object such as tree branches, gravel, bushes, etc.
- **Size** – a large object usually reflects more energy than a smaller object.
- **Composition** – a metal object typically reflects more energy than a non-metallic object.
- **Shape** – complex shapes cause energy to be returned in a very non-uniform way. Very small variations or movement can change detection status.

Minimal reflection

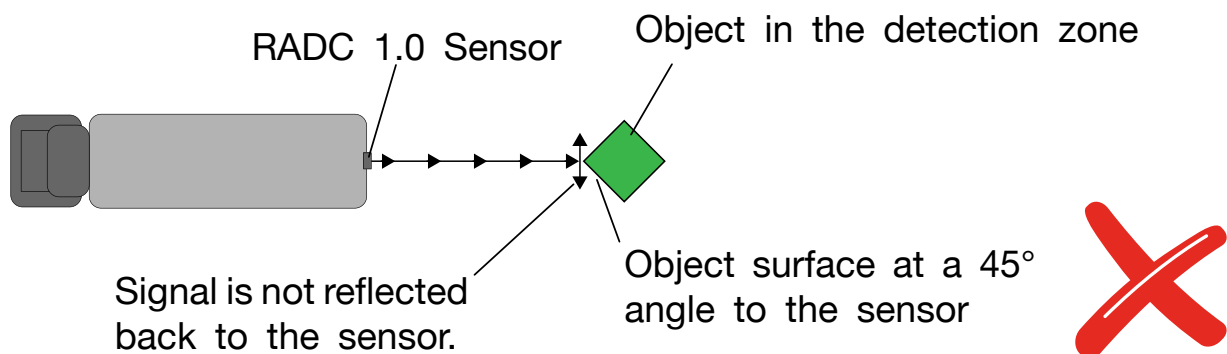

Full reflection

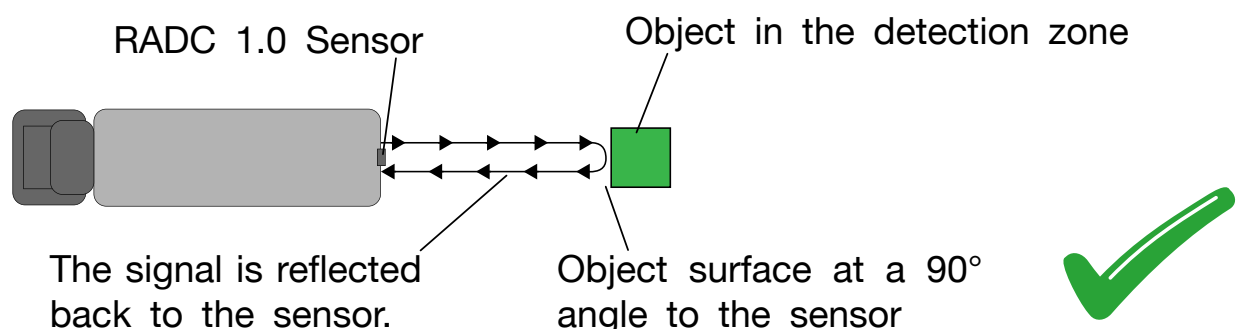

Daily maintenance



1. Failure to follow all safety precautions and instructions may result in property damage, serious injury, or death. It is necessary to read, understand and follow all instructions shipped with the product.
2. Systems on operating equipment must be tested each day prior to the equipment operation. The equipment operator must check for proper operation at the beginning of every shift or safety inspection period.
3. The RADC 1.0 system is intended as an Object Detection System and should not be relied upon as your first line of defense for the safe operation of the equipment. It should be used in conjunction with established safety programs and procedures to augment the safe operation of the equipment, ground personnel, and adjacent property.
4. People's lives depend on the proper installation of this product in conformance with these instructions. Should the system become inoperative, it could jeopardize the safety or lives of those who depend on the system.
5. The RADC 1.0 Object Detection System is intended for commercial use. Proper installation of the object detection system requires a good understanding of equipment electrical systems and procedures, along with proficiency in the installation.
6. Store these instructions in a safe place and refer to them when maintaining and/or reinstalling the system.

Testing and maintenance



NOTE: A walk around test shall be performed every day to verify proper function of the system and to familiarize the operator with the zone of detection. More frequent inspections should be performed when:

- The equipment is operating in a particularly dirty or harsh environment.
- The operator has reason to suspect the system has been damaged.

This test should be performed with two people, the operator who remains in the cab, and the assistant who walks through the sensor field (detection zone).

1. Move the equipment to an open field larger than the detection zone to test.
2. Clean the sensor face of any accumulation of dirt, mud, snow, ice, or debris.
3. Visually inspect the attached wiring and cable and verify that they are properly secured, not chafing or dangling free where they could become snagged and damaged. Inspect the RADC 1.0 Sensor and verify that they are securely attached to the equipment.
4. Place the sensor in active mode. Make sure the equipment has been secured and remains stationary.
5. Verify the sensor is operational. Depending on operator notification, this may be: status lamp or beep (buzzer).
6. Assure the detection zone has been cleared of all obstacles. Any obstacles in the detection zone will interfere with the test.
7. The assistant should walk across the sensor field while the operator notes when the warning activates, signifying the sensor has detected the assistant and identifying the detection zone limits.
8. Next, the assistant should walk from the center of the sensor field straight back, away from the equipment (the center line of the detection zone) while the operator notes when the warning (notification) stops.
9. The assistant should move to a point near the center of the detection zone and remain still for a few seconds, the warning should continue, demonstrating the system's ability to detect a still object.
10. The assistant should walk the complete sensor field while the operator notes the detection edges of the entire coverage area.
11. Finally, after the test the operator and the assistant need to communicate the details on the detection zone.

Specifications

General	
Nominal voltage	24V DC
Voltage range	9 – 33V
Power consumption (total system)	> 1A
Working temperature range	-40°C — +50°C
Storage temperature range	-40°C — +80°C
International protection rating (IP) (ASS-Junction-Box)	IP68
International protection rating (IP) (Connectors + Sensor)	IP6K9K
Homologation	 10R-05 177

Programming



The change of brake- and radar settings, must be executed exclusively by qualified and well-trained specialist operators!

First the sensor must be unplugged, then connected to the laptop with a USB/CAN adapter. To change brake settings, the corresponding hardware and software from the brake manufacturer are needed. Be sure that you are using the most recent software. There are three compatible EBS manufacturers and they must be programmed differently.

Brake configuration (examples)

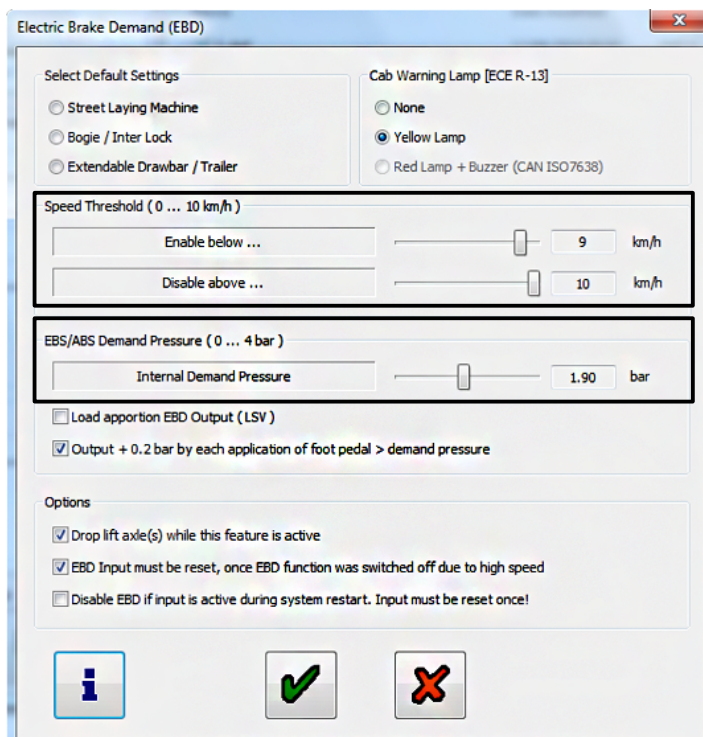

← Max. speed

← Brake pressure



KNORR-BREMSE

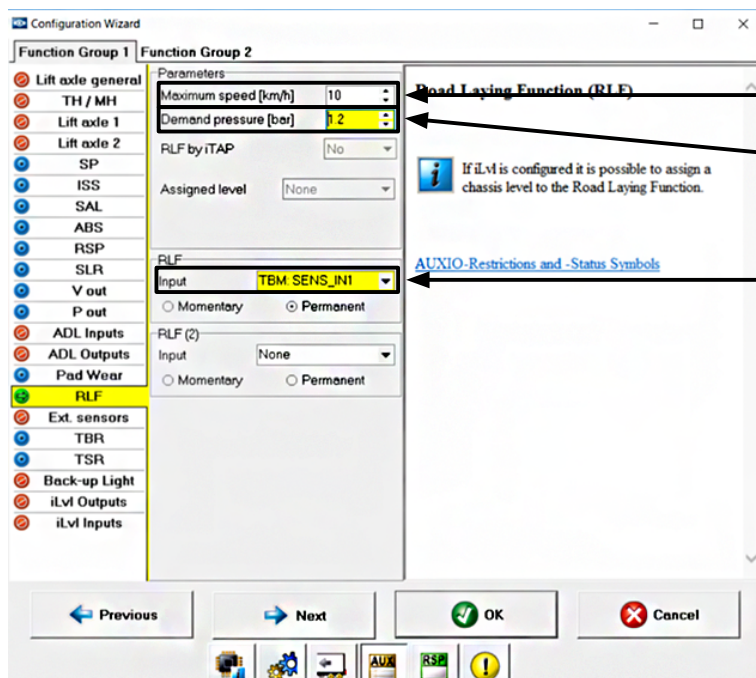

Max. speed
 Brake pressure
 System input

WABCO

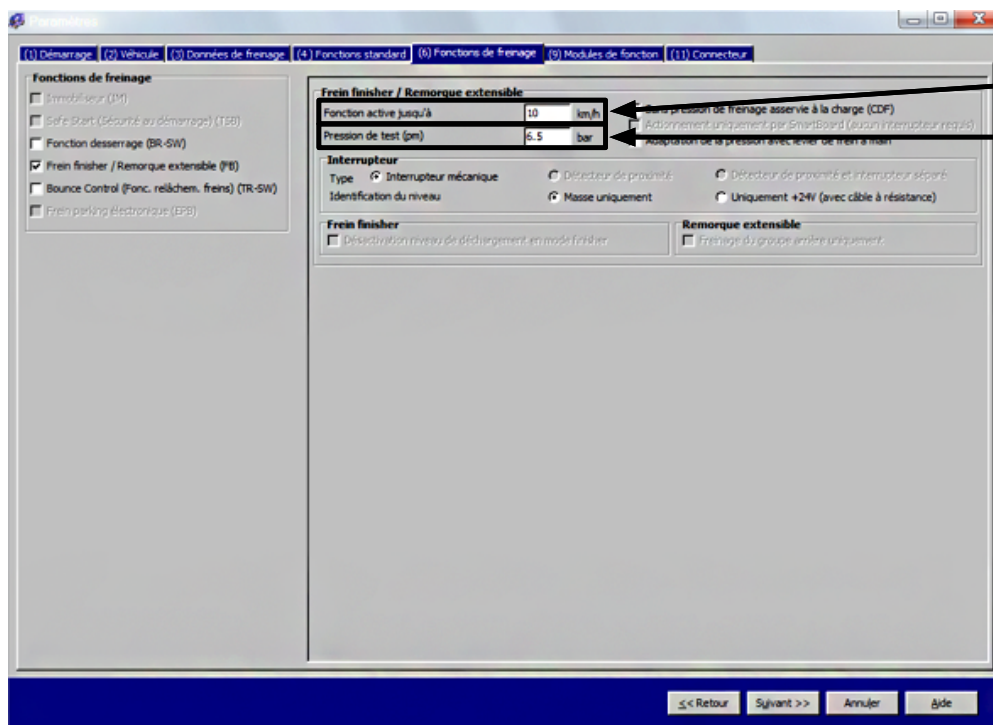

Max. speed
 Brake pressure

Product liabilities

- Manufacturer warrants that on the Date of Purchase this Product will conform to Manufacturer's published specifications for the product, which are available from Manufacturer on request, and Manufacturer warrants that the product is free from defects in materials and workmanship. Manufacturer will, at its option, repair or replace any product found by Manufacturer to be defective and subject to this Limited Warranty.
- This Limited Warranty does not apply to parts or products that are misused; abused; modified; damaged by accident, fire or other hazard; improperly installed or operated; or not maintained in accordance with the maintenance procedures set forth in Manufacturer's Installation and Operating Instructions.
- Exclusion of other warranties: manufacturer makes no other warranties, expressed, implied or statutory. The implied warranties for merchantability and fitness for a particular purpose are hereby excluded and shall not apply to the product. Buyer's sole and exclusive remedy in contract, tort or under any other theory against manufacturer respecting the product and its use shall be the replacement or repair of the product as described above.
- Limitation of liability: in the event of liability for damages arising out of this limited warranty or any other claim related to manufacturer's products, manufacturer's liability for damages shall be limited to the amount paid for the product at the time of original purchase. In no event shall manufacturer be liable for lost profits, the cost of substitute equipment or labor, property damage, or other special, consequential or incidental damages based upon any claim for breach of contract, negligence or other claim, even if manufacturer or a manufacturer's representative has been advised of the possibility of such damages.
- Manufacturer shall have no further obligation or liability with respect to the product or its sale, operation and use, and Manufacturer neither assumes nor authorizes the assumption of any other obligation or liability in connection with such product.
- This Limited Warranty gives you specific legal rights, and you may also have other legal rights, which vary, from state to state. Some states do not allow the exclusion or limitation of incidental or consequential damages, so the above exclusion or limitation may not apply to you.
- Any oral statements or representations about the product, which may have been made by salesmen or Manufacturer representatives, do not constitute warranties. This Limited Warranty may not be amended, modified or enlarged, except by a written agreement signed by an authorized official of Manufacturer that expressly refers to this Limited Warranty.