



GERICHTETE WARNLEUCHTEN













ED3700 Series R65 Class I & II Aufbau-Montage

Diese vielseitigen LED Leuchten zur Aufbau-Montage verfügen über leistungsstarke LED, welche eine äußerst effiziente Warnwirkung erzielen. Sie sind synchronisierbar und zugelassen nach ECE R65 Class I & II. Ein kompaktes Design, Wartungsfreiheit und eine 5-Jahres-Garantie sind nur einige der Vorzüge dieser Serie. Die ED3700 Serie umfasst Single- oder Dual-Colour-Varianten, sowie ein- oder zweireihige Modelle. Eine Auswahl an verschiedenen Montagehaltern erweitert die vielfältigen Befestigungsoptionen.

Leistungsmerkmale und Vorteile

- 12-24 VDC
- Gleiches Lochbild wie die 3700 Serie
- Single- und Dual-Colour Optionen mit einstellbaren Blitzmustern
- Synchronisierbar, 2 Helligkeitsstufen und Dauerlicht-Modus
- Einreihige Modelle (ED3703/04/44/05/55) und zweireihige Modelle (ED3788/89)
- Polycarbonat Lichtscheibe und wasserfestes Gehäuse für eine längere Lebensdauer
- Temperaturbereich: -40°C bis +65°C

Modelle

PART NO.	TYPE	FLASH PATTERNS	COLOUR	R65 APPROVALS
ED3703A	3 LED	21		R65 Class I
XTP3B	3 LED	21		R65 Class I
XTP3W	3 LED	21		-
ED3703G	3 LED	21		-
XTP3R	3 LED	21		R65 Class II
ED3704A	4 LED	30		R65 Class II
XTP4BB	4 LED	30		R65 Class II
XTP4WW	4 LED	30		-
ED3704G	4 LED	30		-
XTP4RR	4 LED	30		R65 Class II

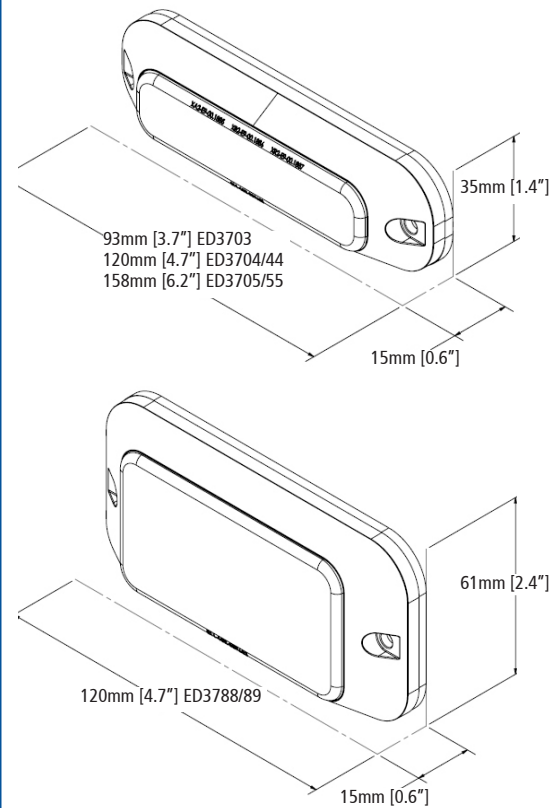





































Zubehör

- Schwarzer Rahmen (im Lieferumfang enthalten)
- 90° Halter
- Rahmen für versenkten Einbau
- Halter für Kühlergrill

+49 (0)731 935210 ulm@eccogroup.com

Modelle

ED3705A	6 LED	30		R65 Class II
XTP6BB	6 LED	30		R65 Class II
XTP6WW	6 LED	30		-
ED3705G	6 LED	30		-
XTP6RR	6 LED	30		R65 Class II
ED3744AC	8 LED	-		R65 Class II 
XTP4MCBA	8 LED	70		R65 Class II  Class I 
XTP4MCRA	8 LED	70		R65 Class II
XTP4MCBW	8 LED	70		R65 Class I 
XTP4MCRB	8 LED	70		R65 Class II  Class I 
XTP4MCRW	8 LED	70		R65 Class II 
ED3755AC	12 LED	-		R65 Class II 
XTP6MCBA	12 LED	70		R65 Class II
XTP6MCRA	12 LED	70		R65 Class II
XTP6MCBW	12 LED	70		R65 Class II 
XTP6MCRB	12 LED	70		R65 Class II
XTP6MCRW	12 LED	70		R65 Class II
ED3788A	8 LED	62		R65** Class II
XTP4DSBB	8 LED	62		R65** Class II
XTP4DSWW	8 LED	62		-
XTP4DSRR	8 LED	62		R65** Class II
ED3789AC	16 LED	70		R65** Class II
XTP4DSMCBA	16 LED	70		R65** Class II
XTP4DSMCBW	16 LED	70		R65** Class II
XTP4DSMCRA	16 LED	70		R65** Class II
XTP4DSMCRB	16 LED	70		R65** Class II
XTP4DSMCRW	16 LED	70		R65** Class II

Zubehör

ACCESSORY	MOUNT
CZXTP3BZL	Black bezel kit
XTP3CHMBZ	Chrome plated bezel
XT3GRL	Bolt on grill bracket
XT3LBKT	Aluminium, painted black bracket
XTP3RUBZ	Black rubber bezel for XTP3
CZXTP4BZL	Black bezel kit
XTP4CHMBZ	Chrome plated bezel
XT4GRL	Bolt on grill bracket
XT4LBKT	Aluminium, painted black bracket
XTP4RUBZ	Black rubber bezel for XTP4
CZXTP6BZL	Black bezel kit
XTP6CHMBZ	Chrome plated, screw mount
XT6GRL	Bolt on grill bracket
XT6LBKT	Aluminium, painted black bracket
XTP6RUBZ	Black rubber bezel for XTP6
CZXTP4DSBZL	Black bezel kit

