

P10

workshop tool trolley
with 241 tools for 4 drawers
810.4241

Workshop trolley P10

with 8 compartments

873.0008

THE ENTRY MODEL TO SATISFY HIGH STANDARDS



P10



DUO Lock Brilliant locking system



Eight drawers each load capacity up to 50 kg



Stable **ball bearing**



Stainless steel surface

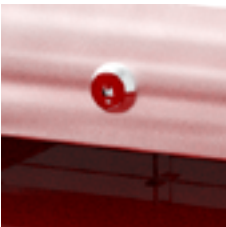

Lock lockable



Anti-static castors with brakes



Integrated **corner protection**



Paper roll holder included



Can holder included

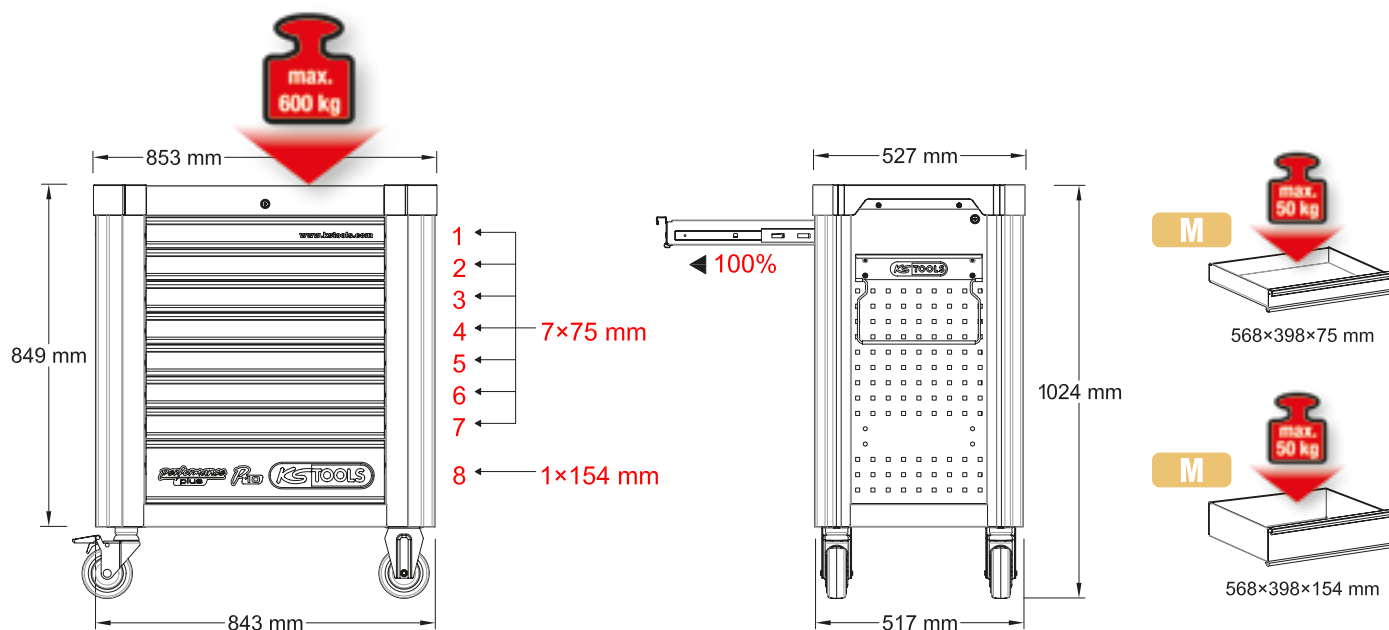

P10 workshop tool trolley set with 241 tools for 4 drawers

810.4241

PCS
241

M

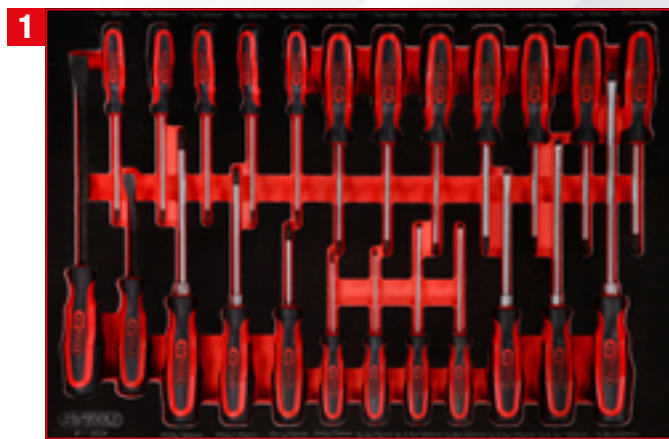

Screwdriver set in foam insert

811.0024

PCS
24



1/4" + 3/8" + 1/2" socket
spanner set in foam insert

811.0159

PCS
159



Screw spanner set in foam insert

811.1041

PCS
41



Pliers, hammer and chisel
set in foam insert

811.0017

PCS
17

811.0024

M Screwdriver set

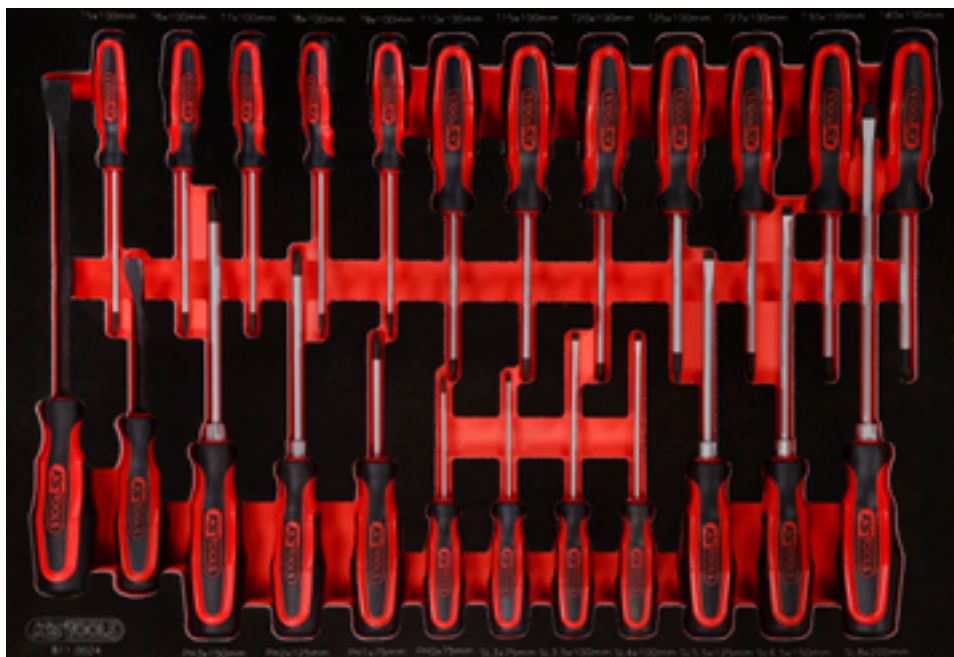

| Pos. | Code | Description | pcs |
|------|----------|---|-----|
| 1 | 911.8102 | Pry bar, 15 x 185 mm | 1 |
| 2 | 911.8101 | Pry bar, 11 x 115 mm | 1 |
| 3 | 159.1133 | ERGOTORQUEplus screwdriver, Torx, T5 | 1 |
| 4 | 159.1134 | ERGOTORQUEplus screwdriver, Torx, T6 | 1 |
| 5 | 159.1135 | ERGOTORQUEplus screwdriver, Torx, T7 | 1 |
| 6 | 159.1030 | ERGOTORQUEplus screwdriver, Torx, T8 | 1 |
| 7 | 159.1031 | ERGOTORQUEplus screwdriver, Torx, T9 | 1 |
| 8 | 159.1032 | ERGOTORQUEplus screwdriver, Torx, T10 | 1 |
| 9 | 159.1033 | ERGOTORQUEplus screwdriver, Torx, T15 | 1 |
| 10 | 159.1034 | ERGOTORQUEplus screwdriver, Torx, T20 | 1 |
| 11 | 159.1035 | ERGOTORQUEplus screwdriver, Torx, T25 | 1 |
| 12 | 159.1036 | ERGOTORQUEplus screwdriver, Torx, T27 | 1 |
| 13 | 159.1037 | ERGOTORQUEplus screwdriver, Torx, T30 | 1 |
| 14 | 159.1038 | ERGOTORQUEplus screwdriver, Torx, T40 | 1 |
| 15 | 159.1024 | ERGOTORQUEplus screwdriver, Torx, PH3, 265 mm | 1 |
| 16 | 159.1022 | ERGOTORQUEplus screwdriver, Torx, PH2, 230 mm | 1 |
| 17 | 159.1020 | ERGOTORQUEplus screwdriver, Torx, PH1, 180 mm | 1 |
| 18 | 159.1027 | ERGOTORQUEplus screwdriver, Torx, PH0, 155 mm | 1 |
| 19 | 159.1002 | ERGOTORQUEplus screwdriver for slotted screws, 3 mm, 155 mm | 1 |
| 20 | 159.1112 | ERGOTORQUEplus screwdriver for slotted screws, 3,5 mm, 180 mm | 1 |
| 21 | 159.1004 | ERGOTORQUEplus screwdriver for slotted screws, 4 mm, 180 mm | 1 |
| 22 | 159.1006 | ERGOTORQUEplus screwdriver for slotted screws, 5,5 mm, 230 mm | 1 |
| 23 | 159.1009 | ERGOTORQUEplus screwdriver for slotted screws, 6,5 mm, 255 mm | 1 |
| 24 | 159.1011 | ERGOTORQUEplus screwdriver for slotted screws, 8 mm, 315 mm | 1 |

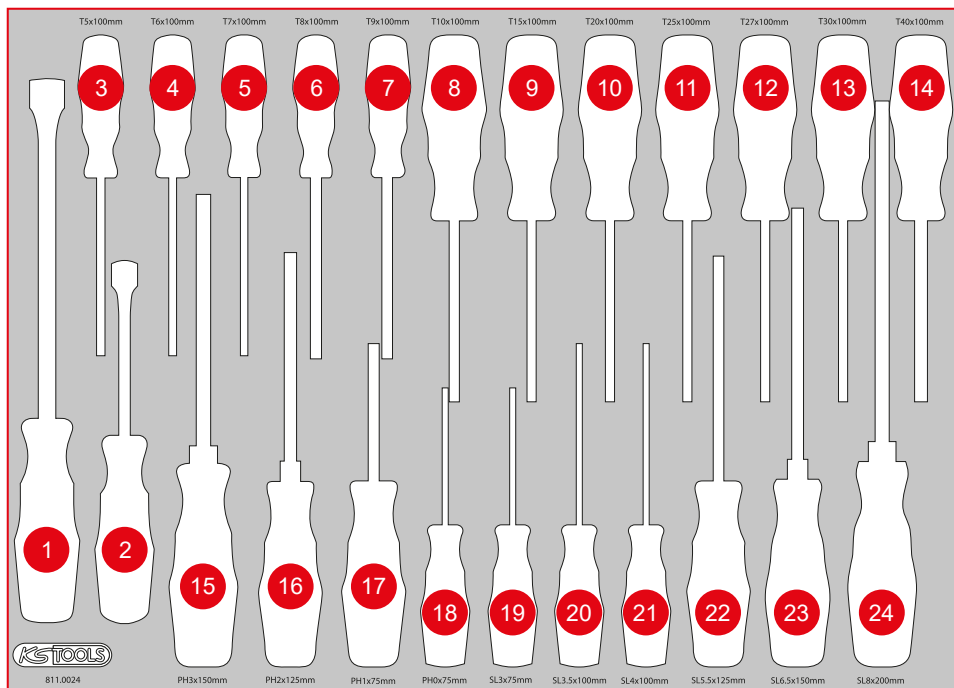

M 1/4" + 3/8" + 1/2" Socket spanner set



568 x 398



P10



P10TC



P15



P20



P30



P35



P45

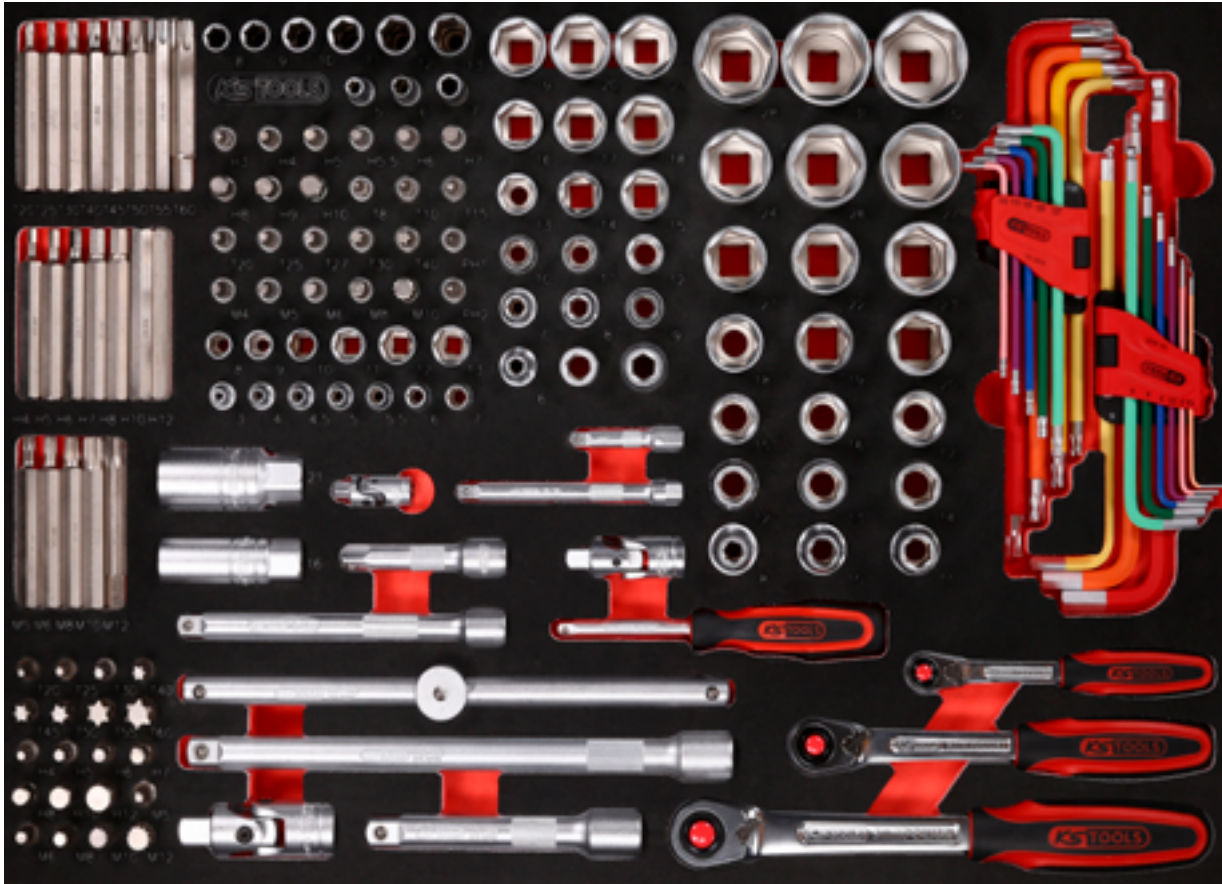

| Pos. | Code | Description | pcs | Pos. | Code | Description | pcs | Pos. | Code | Description | pcs |
|------|----------|-----------------------------------|-----|------|----------|------------------------------------|-----|------|-----------|-----------------------------------|-----|
| 1 | 975.2020 | 10 mm Bit Torx, 75 mm, T20 | 1 | 26 | 930.2050 | 10 mm Bit Torx, 30 mm, T50 | 1 | 51 | 911.1437 | 1/4" Bit socket hexagon, 4 mm | 1 |
| 2 | 975.2025 | 10 mm Bit Torx, 75 mm, T25 | 1 | 27 | 930.2055 | 10 mm Bit Torx, 30 mm, T55 | 1 | 52 | 911.1438 | 1/4" Bit socket hexagon, 5 mm | 1 |
| 3 | 975.2030 | 10 mm Bit Torx, 75 mm, T30 | 1 | 28 | 930.2060 | 10 mm Bit Torx, 30 mm, T60 | 1 | 53 | 911.14385 | 1/4" Bit socket hexagon, 5,5 mm | 1 |
| 4 | 975.2040 | 10 mm Bit Torx, 75 mm, T40 | 1 | 29 | 930.1004 | 10 mm Bit hexagonal, 30 mm, 4 mm | 1 | 54 | 911.1439 | 1/4" Bit socket hexagon, 6 mm | 1 |
| 5 | 975.2045 | 10 mm Bit Torx, 75 mm, T45 | 1 | 30 | 930.1005 | 10 mm Bit hexagonal, 30 mm, 5 mm | 1 | 55 | 911.1440 | 1/4" Bit socket hexagon, 7 mm | 1 |
| 6 | 975.2050 | 10 mm Bit Torx, 75 mm, T50 | 1 | 31 | 930.1006 | 10 mm Bit hexagonal, 30 mm, 6 mm | 1 | 56 | 911.1441 | 1/4" Bit socket hexagon, 8 mm | 1 |
| 7 | 975.2055 | 10 mm Bit Torx, 75 mm, T55 | 1 | 32 | 930.1007 | 10 mm Bit hexagonal, 30 mm, 7 mm | 1 | 57 | 917.1454 | 1/4" Bit socket hexagon, 9 mm | 1 |
| 8 | 975.2060 | 10 mm Bit Torx, 75 mm, T60 | 1 | 33 | 930.1008 | 10 mm Bit hexagonal, 30 mm, 8 mm | 1 | 58 | 917.1452 | 1/4" Bit socket hexagon, 10 mm | 1 |
| 9 | 975.1004 | 10 mm Bit hexagonal, 75 mm, 4 mm | 1 | 34 | 930.1010 | 10 mm Bit hexagonal, 30 mm, 10 mm | 1 | 59 | 911.1448 | 1/4" Bit socket Torx, T8 | 1 |
| 10 | 975.1005 | 10 mm Bit hexagonal, 75 mm, 5 mm | 1 | 35 | 930.1012 | 10 mm Bit hexagonal, 30 mm, 12 mm | 1 | 60 | 911.1442 | 1/4" Bit socket Torx, T10 | 1 |
| 11 | 975.1006 | 10 mm Bit hexagonal, 75 mm, 6 mm | 1 | 36 | 930.3005 | 10 mm Bit spline XZN, 30 mm, M5 | 1 | 61 | 911.1443 | 1/4" Bit socket Torx, T15 | 1 |
| 12 | 975.1007 | 10 mm Bit hexagonal, 75 mm, 7 mm | 1 | 37 | 930.3006 | 10 mm Bit spline XZN, 30 mm, M6 | 1 | 62 | 911.1444 | 1/4" Bit socket Torx, T20 | 1 |
| 13 | 975.1008 | 10 mm Bit hexagonal, 75 mm, 8 mm | 1 | 38 | 930.3008 | 10 mm Bit spline XZN, 30 mm, M8 | 1 | 63 | 911.1445 | 1/4" Bit socket Torx, T25 | 1 |
| 14 | 975.1010 | 10 mm Bit hexagonal, 75 mm, 10 mm | 1 | 39 | 930.3010 | 10 mm Bit spline XZN, 30 mm, M10 | 1 | 64 | 911.1449 | 1/4" Bit socket Torx, T27 | 1 |
| 15 | 975.1012 | 10 mm Bit hexagonal, 75 mm, 12 mm | 1 | 40 | 930.3012 | 10 mm Bit spline XZN, 30 mm, M12 | 1 | 65 | 911.1446 | 1/4" Bit socket Torx, T30 | 1 |
| 16 | 975.3005 | 10 mm Bit spline XZN, 75 mm, M5 | 1 | 41 | 917.1428 | 1/4" Hexagonal socket, deep, 8 mm | 1 | 66 | 911.1447 | 1/4" Bit socket Torx, T40 | 1 |
| 17 | 975.3006 | 10 mm Bit spline XZN, 75 mm, M6 | 1 | 42 | 917.1429 | 1/4" Hexagonal socket, deep, 9 mm | 1 | 67 | 911.1415 | 1/4" Bit socket, PH1 | 1 |
| 18 | 975.3008 | 10 mm Bit spline XZN, 75 mm, M8 | 1 | 43 | 917.1430 | 1/4" Hexagonal socket, deep, 10 mm | 1 | 68 | 917.1541 | 1/4" Bit socket spline (XZN), M4 | 1 |
| 19 | 975.3010 | 10 mm Bit spline XZN, 75 mm, M10 | 1 | 44 | 917.1431 | 1/4" Hexagonal socket, deep, 11 mm | 1 | 69 | 917.1542 | 1/4" Bit socket spline (XZN), M5 | 1 |
| 20 | 975.3012 | 10 mm Bit spline XZN, 75 mm, M12 | 1 | 45 | 917.1432 | 1/4" Hexagonal socket, deep, 12 mm | 1 | 70 | 917.1543 | 1/4" Bit socket spline (XZN), M6 | 1 |
| 21 | 930.2020 | 10 mm Bit Torx, 30 mm, T20 | 1 | 46 | 917.1433 | 1/4" Hexagonal socket, deep, 13 mm | 1 | 71 | 917.1545 | 1/4" Bit socket spline (XZN), M8 | 1 |
| 22 | 930.2025 | 10 mm Bit Torx, 30 mm, T25 | 1 | 47 | 917.1527 | 1/4" Hexagonal socket, deep, 5 mm | 1 | 72 | 917.1546 | 1/4" Bit socket spline (XZN), M10 | 1 |
| 23 | 930.2030 | 10 mm Bit Torx, 30 mm, T30 | 1 | 48 | 917.1426 | 1/4" Hexagonal socket, deep, 6 mm | 1 | 73 | 911.1416 | 1/4" Bit socket, PH2 | 1 |
| 24 | 930.2040 | 10 mm Bit Torx, 30 mm, T40 | 1 | 49 | 917.1427 | 1/4" Hexagonal socket, deep, 7 mm | 1 | 74 | 917.1408 | 1/4" Hexagonal socket, 8 mm | 1 |
| 25 | 930.2045 | 10 mm Bit Torx, 30 mm, T45 | 1 | 50 | 911.1436 | 1/4" Bit socket hexagon, 3 mm | 1 | 75 | 917.1409 | 1/4" Hexagonal socket, 9 mm | 1 |

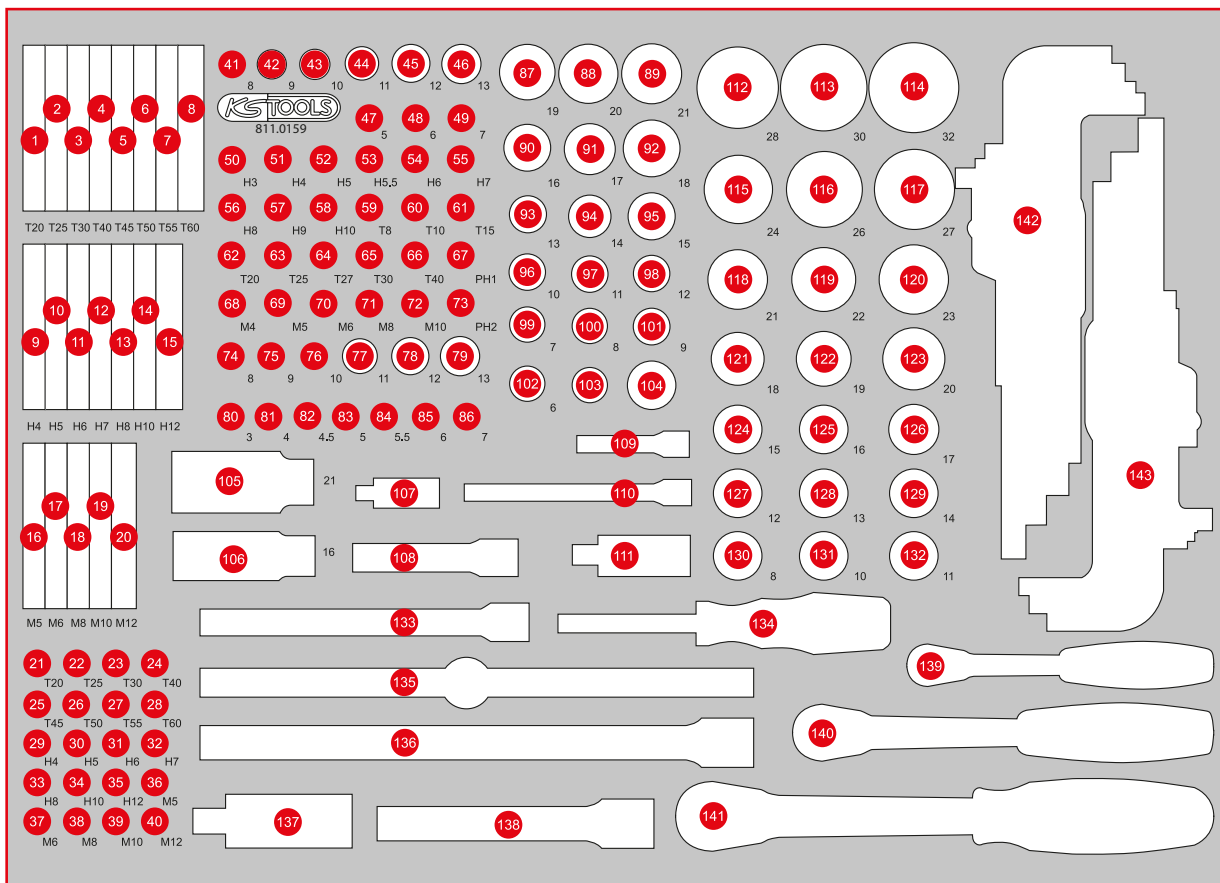

| Pos. | Code | Description | pcs | Pos. | Code | Description | pcs | Pos. | Code | Description | pcs |
|------|-----------|-------------------------------|-----|------|----------|---|-----|------|----------|--|-----|
| 76 | 917.1410 | 1/4" Hexagonal socket, 10 mm | 1 | 101 | 917.3809 | 3/8" Hexagonal socket, 9 mm | 1 | 126 | 917.1217 | 1/2" Hexagonal socket, 17 mm | 1 |
| 77 | 917.1411 | 1/4" Hexagonal socket, 11 mm | 1 | 102 | 917.3806 | 3/8" Hexagonal socket, 6 mm | 1 | 127 | 917.1212 | 1/2" Hexagonal socket, 12 mm | 1 |
| 78 | 917.1412 | 1/4" Hexagonal socket, 12 mm | 1 | 103 | 911.4311 | 3/8" Bit adaptor socket, for bits 10 mm | 1 | 128 | 917.1213 | 1/2" Hexagonal socket, 13 mm | 1 |
| 79 | 917.1413 | 1/4" Hexagonal socket, 13 mm | 1 | 105 | 911.3805 | 3/8" Spark plug socket, 21 mm | 1 | 129 | 917.1214 | 1/2" Hexagonal socket, 14 mm | 1 |
| 80 | 917.1445 | 1/4" Hexagonal socket, 3 mm | 1 | 105 | 911.4312 | 1/2" Bit adaptor socket, for bits 10 mm | 1 | 130 | 917.1340 | 1/2" Hexagonal socket, 8 mm | 1 |
| 81 | 917.1404 | 1/4" Hexagonal socket, 4 mm | 1 | 106 | 911.3804 | 3/8" Spark plug socket, 16 mm | 1 | 131 | 917.1210 | 1/2" Hexagonal socket, 10 mm | 1 |
| 82 | 917.14045 | 1/4" Hexagonal socket, 4,5 mm | 1 | 107 | 911.1450 | 1/4" Universal joint | 1 | 132 | 917.1211 | 1/2" Hexagonal socket, 11 mm | 1 |
| 83 | 917.1405 | 1/4" Hexagonal socket, 5 mm | 1 | 108 | 911.3801 | 3/8" Extension with knurling, 75 mm | 1 | 133 | 911.3802 | 3/8" Extension with knurling, 150 mm | 1 |
| 84 | 917.14055 | 1/4" Hexagonal socket, 5,5 mm | 1 | 109 | 911.1423 | 1/4" Extension with hexagon drive, 50 mm | 1 | 134 | 911.1434 | 1/4" Square drive screwdriver, 150 mm | 1 |
| 85 | 917.1406 | 1/4" Hexagonal socket, 6 mm | 1 | 110 | 911.1424 | 1/4" Extension with hexagon drive, 100 mm | 1 | 135 | 911.1204 | Sliding T-bar, 1/2", 250 mm | 1 |
| 86 | 917.1407 | 1/4" Hexagonal socket, 7 mm | 1 | 111 | 911.3850 | 3/8" Universal joint | 1 | 136 | 911.1203 | 1/2" Extensions, 250 mm | 1 |
| 87 | 917.3819 | 3/8" Hexagonal socket, 19 mm | 1 | 112 | 917.1344 | 1/2" Hexagonal socket, 28 mm | 1 | 137 | 911.1250 | 1/2" Universal joint | 1 |
| 88 | 917.3820 | 3/8" Hexagonal socket, 20 mm | 1 | 113 | 917.1230 | 1/2" Hexagonal socket, 30 mm | 1 | 138 | 911.1202 | 1/2" Extensions, 125 mm | 1 |
| 89 | 917.3821 | 3/8" Hexagonal socket, 21 mm | 1 | 114 | 917.1232 | 1/2" Hexagonal socket, 32 mm | 1 | 139 | 920.1490 | 1/4" SlimPOWER Reversible ratchet, 72 teeth | 1 |
| 90 | 917.3816 | 3/8" Hexagonal socket, 16 mm | 1 | 115 | 917.1224 | 1/2" Hexagonal socket, 24 mm | 1 | 140 | 920.3890 | 3/8" SlimPOWER Reversible ratchet, 72 teeth | 1 |
| 91 | 917.3817 | 3/8" Hexagonal socket, 17 mm | 1 | 116 | 917.1343 | 1/2" Hexagonal socket, 26 mm | 1 | 141 | 920.1290 | 1/2" SlimPOWER Reversible ratchet, 72 teeth | 1 |
| 92 | 917.3818 | 3/8" Hexagonal socket, 18 mm | 1 | 117 | 917.1227 | 1/2" Hexagonal socket, 27 mm | 1 | 142 | 151.5210 | Ball head Torx angled socket wrench set, extra long, 9 pcs | 9 |
| 93 | 917.3813 | 3/8" Hexagonal socket, 13 mm | 1 | 118 | 917.1221 | 1/2" Hexagonal socket, 21 mm | 1 | 143 | 151.4420 | Ball ended hexagon key wrench set, extra long, 9 pcs | 9 |
| 94 | 917.3814 | 3/8" Hexagonal socket, 14 mm | 1 | 119 | 917.1222 | 1/2" Hexagonal socket, 22 mm | 1 | | | | |
| 95 | 917.3815 | 3/8" Hexagonal socket, 15 mm | 1 | 120 | 917.1223 | 1/2" Hexagonal socket, 23 mm | 1 | | | | |
| 96 | 917.3810 | 3/8" Hexagonal socket, 10 mm | 1 | 121 | 917.1218 | 1/2" Hexagonal socket, 18 mm | 1 | | | | |
| 97 | 917.3811 | 3/8" Hexagonal socket, 11 mm | 1 | 122 | 917.1219 | 1/2" Hexagonal socket, 19 mm | 1 | | | | |
| 98 | 917.3812 | 3/8" Hexagonal socket, 12 mm | 1 | 123 | 917.1220 | 1/2" Hexagonal socket, 20 mm | 1 | | | | |
| 99 | 917.3807 | 3/8" Hexagonal socket, 7 mm | 1 | 124 | 917.1215 | 1/2" Hexagonal socket, 15 mm | 1 | | | | |
| 100 | 917.3808 | 3/8" Hexagonal socket, 8 mm | 1 | 125 | 917.1216 | 1/2" Hexagonal socket, 16 mm | 1 | | | | |

M Screw spanner set

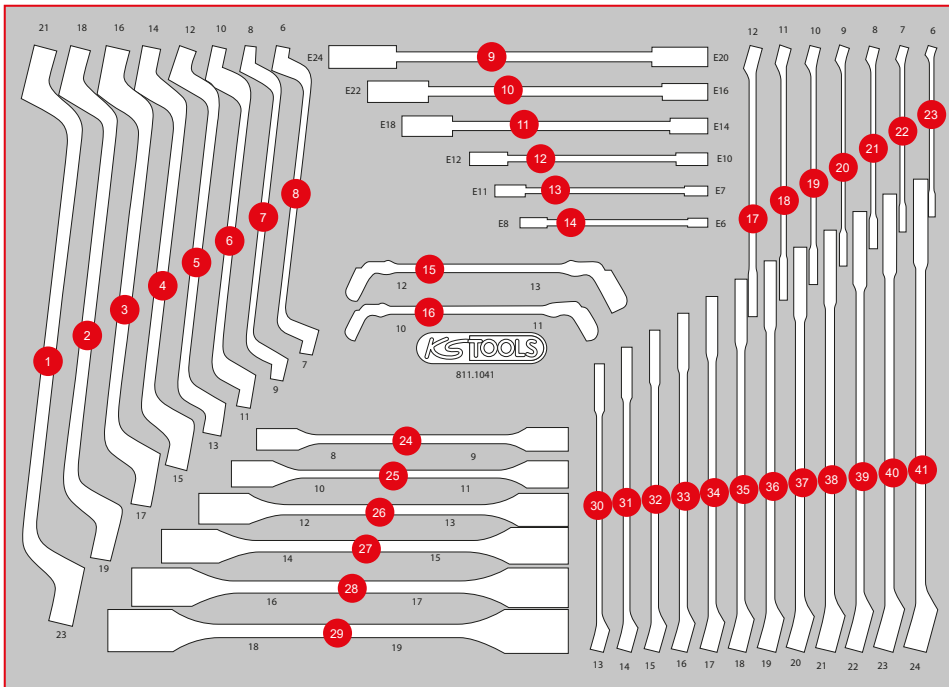
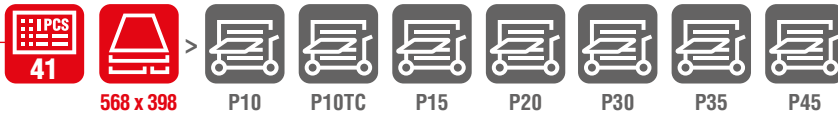

| Pos. | Code | Description | pcs |
|------|----------|---|-----|
| 1 | 517.0815 | Double ring spanner, offset, 21 x 23 mm | 1 |
| 2 | 517.0812 | Double ring spanner, offset, 18 x 19 mm | 1 |
| 3 | 517.0810 | Double ring spanner, offset, 16 x 17 mm | 1 |
| 4 | 517.0809 | Double ring spanner, offset, 14 x 15 mm | 1 |
| 5 | 517.0807 | Double ring spanner, offset, 12 x 13 mm | 1 |
| 6 | 517.0804 | Double ring spanner, offset, 10 x 11 mm | 1 |
| 7 | 517.0802 | Double ring spanner, offset, 8 x 9 mm | 1 |
| 8 | 517.0801 | Double ring spanner, offset, 6 x 7 mm | 1 |
| 9 | 911.0376 | Double ring spanner for Torx E profile, E20 x E24 | 1 |
| 10 | 911.0375 | Double ring spanner for Torx E profile, E16 x E22 | 1 |
| 11 | 911.0374 | Double ring spanner for Torx E profile, E14 x E18 | 1 |
| 12 | 911.0373 | Double ring spanner for Torx E profile, E10 x E12 | 1 |
| 13 | 911.0372 | Double ring spanner for Torx E profile, E7 x E11 | 1 |
| 14 | 911.0371 | Double ring spanner for Torx E profile, E6 x E8 | 1 |
| 15 | 518.0529 | Open double ring spanner, with double joint, 12 x 13 mm | 1 |
| 16 | 518.0528 | Open double ring spanner, with double joint, 10 x 11 | 1 |
| 17 | 517.0612 | Combination spanners, offset, 12 mm | 1 |
| 18 | 517.0611 | Combination spanners, offset, 11 mm | 1 |
| 19 | 517.0610 | Combination spanners, offset, 10 mm | 1 |
| 20 | 517.0609 | Combination spanners, offset, 9 mm | 1 |
| 21 | 517.0608 | Combination spanners, offset, 8 mm | 1 |
| 22 | 517.0607 | Combination spanners, offset, 7 mm | 1 |
| 23 | 517.0606 | Combination spanners, offset, 6 mm | 1 |
| 24 | 517.0301 | Double revolving head spanner, 8 x 9 mm | 1 |
| 25 | 517.0302 | Double revolving head spanner, 10 x 11 mm | 1 |
| 26 | 517.0303 | Double revolving head spanner, 12 x 13 mm | 1 |
| 27 | 517.0304 | Double revolving head spanner, 14 x 15 mm | 1 |
| 28 | 517.0305 | Double revolving head spanner, 16 x 17 mm | 1 |
| 29 | 517.0306 | Double revolving head spanner, 18 x 19 mm | 1 |
| 30 | 517.0613 | Combination spanners, offset, 13 mm | 1 |
| 31 | 517.0614 | Combination spanners, offset, 14 mm | 1 |
| 32 | 517.0615 | Combination spanners, offset, 15 mm | 1 |
| 33 | 517.0616 | Combination spanners, offset, 16 mm | 1 |
| 34 | 517.0617 | Combination spanners, offset, 17 mm | 1 |
| 35 | 517.0618 | Combination spanners, offset, 18 mm | 1 |
| 36 | 517.0619 | Combination spanners, offset, 19 mm | 1 |
| 37 | 517.0620 | Combination spanners, offset, 20 mm | 1 |
| 38 | 517.0621 | Combination spanners, offset, 21 mm | 1 |
| 39 | 517.0622 | Combination spanners, offset, 22 mm | 1 |
| 40 | 517.0623 | Combination spanners, offset, 23 mm | 1 |
| 41 | 517.0624 | Combination spanners, offset, 24 mm | 1 |

811.0017

M Pliers, Hammer and chisel set



568 x 398

P10

P10TC

P15

P20

P30

P35

P45



| Pos. | Code | Description | pcs |
|------|----------|---|-----|
| 1 | 157.0205 | Round file, form F, cut 2, 200 mm | 1 |
| 2 | 157.0005 | Flat file, form B, cut 2, 200 mm | 1 |
| 3 | 157.0405 | Tri-bastard file, form C, cut 2, 200 mm | 1 |
| 4 | 157.0105 | Halfround file, form E, cut 2, 20 mm | 1 |
| 5 | 156.0241 | Flat chisel, octagon, 20 mm | 1 |
| 6 | 156.0254 | Flat chisel, octagon, 18 mm | 1 |
| 7 | 201.2335 | Steel wire brake saddle brush, 2-row, straight | 1 |
| 8 | 115.1012 | ERGOTORQUE diagonal side cutter, 160 mm | 1 |
| 9 | 115.1021 | ERGOTORQUE combination pliers, 180 mm | 1 |
| 10 | 300.0114 | Tape measure with locking device and belt clip, black red, 5 m, 19 mm | 1 |
| 11 | 142.1402 | Fitters Hammer, fiberglas handle, 400 g | 1 |
| 12 | 115.1019 | ERGOTORQUE bent nose pliers serrated, 210 mm | 1 |
| 13 | 115.1024 | ERGOTORQUE long nose pliers serrated cutter, 200 mm | 1 |
| 14 | 115.2010 | Water pump pliers, 240 mm | 1 |
| 15 | 115.1033 | Self grip wrench, 220 mm | 1 |
| 16 | 142.5101 | Club Hammer, fiberglas handle, 1000 g | 1 |
| 17 | 550.1001 | 2in1 Telescopic solenoid holder with washer jet cleaning and setting tool, 150-675 mm | 1 |

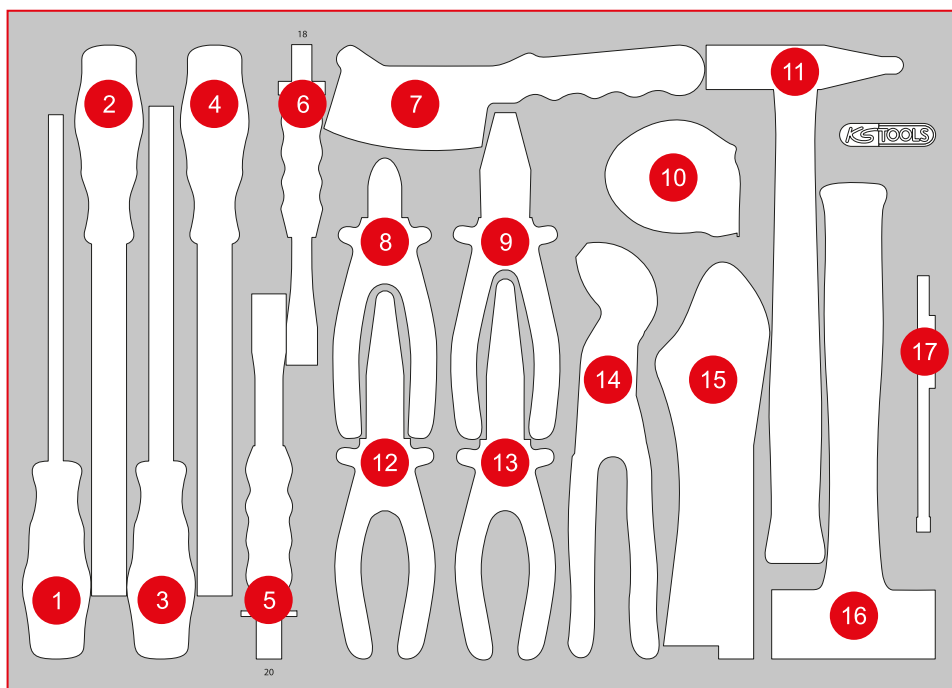

P10

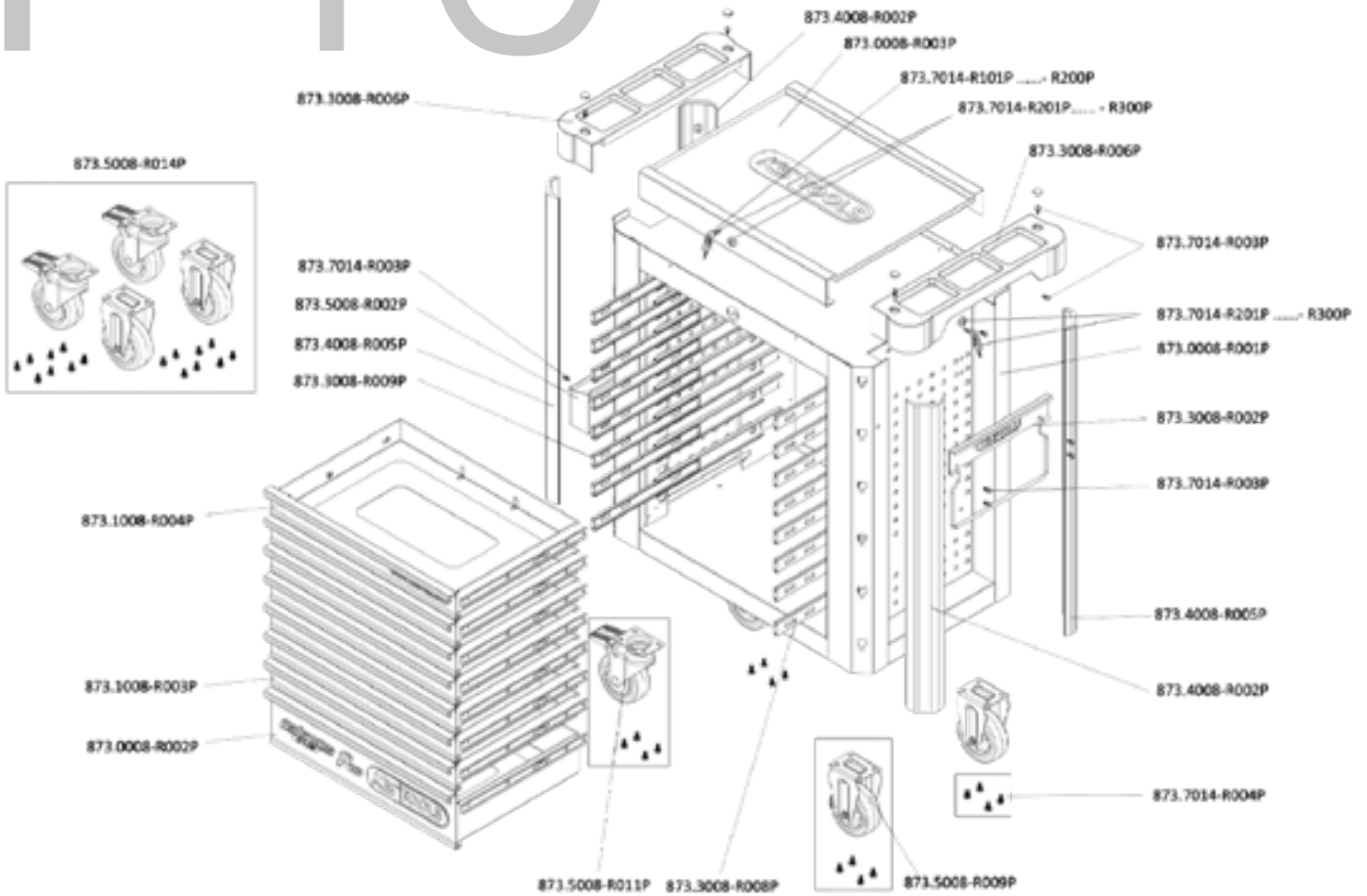

INDIVIDUAL PARTS LIST

| Item No. | Description | Amount |
|-------------------|--|--------|
| 873.7014-R101P... | Replacement key for PERFORMANCEplus workshop trolley lock number xyz | 2 |
| 873.7014-R201P... | Lock with 2 keys for PERFORMANCEplus workshop trolley lock number xyz | 2 |
| 873.0008-R001P | Body with handle | 1 |
| 873.0008-R002P | Compartment with logo and ball-bearing guide, 568x398x145 mm | 1 |
| 873.0008-R003P | Stainless steel worktop | 1 |
| 873.1008-R003P | Compartment with ball-bearing guide, for workshop trolley P10/P10TC/P15, 568x398x65 mm | 6 |
| 873.1008-R004P | Compartment with website and ball-bearing guide, for workshop trolley P10/P15, 568x398x65 mm | 1 |
| 873.3008-R002P | Paper roll holder for PERFORMANCEplus workshop trolley | 1 |
| 873.3008-R006P | Storage for work surface | 2 |
| 873.3008-R008P | Full extension (with ball-bearing guide) with automatic retraction | 8 |
| 873.3008-R009P | Full extension (with ball-bearing guide) with automatic retraction | 8 |
| 873.4008-R002P | Plastic bumpers | 2 |
| 873.4008-R005P | Plastic bumpers | 2 |
| 873.5008-R002P | Can holder for PERFORMANCEplus workshop trolley | 1 |
| 873.5008-R009P | Fixed castors for PERFORMANCEplus workshop trolley, incl. screws | 2 |
| 873.5008-R011P | Swivel castors with brakes, for PERFORMANCEplus workshop trolley, incl. screws | 2 |
| 873.5008-R014P | Roller set for PERFORMANCEplus workshop trolley, incl. screws | 1 |
| 873.7014-R003P | M6x12 screws for PERFORMANCEplus workshop trolley accessories | 14 |
| 873.7014-R004P | M8 screws for PERFORMANCEplus workshop trolley rollers (16 pcs.) | 1 |



873.7014-R101P...R200P
Replacement key for lock number xyz



873.7014-R201P...R300P
Lock with 2 keys for lock number xyz



873.3008-R008P
Full extension (with ball-bearing guide) with automatic retraction, right



873.3008-R009P
Full extension (with ball-bearing guide) with automatic retraction, left



873.5008-R009P
Fixed castors, incl. screws



873.5008-R011P
Swivel castors with brakes, incl. screws



873.5008-R014P
Roller set, incl. screws



873.0008-R003P
Stainless steel work surface



873.3008-R006P
Storage for work surface, including screw cover, usable on both sides



873.1008-R004P
Compartment with website and ball-bearing guide, 568x398x65 mm



873.1008-R003P
Compartment with ball-bearing guide, 568x398x65 mm



873.0008-R002P
Compartment with logo and ball-bearing guide, 568x398x145 mm



873.5008-R002P
Can holder, 310 mm



873.3008-R002P
Paper roll holder, 320 mm



873.4008-R005P
Plastic bumpers, front left, back right



873.4008-R002P
Plastic bumpers, front right, back left



873.7014-R004P
M8 screws (16 pcs.)



873.7014-R003P
M6x12 screw (1 pcs.)



873.0008-R001P
Body with handle



A thousand great parts for tough guys!

